

ELEVATION

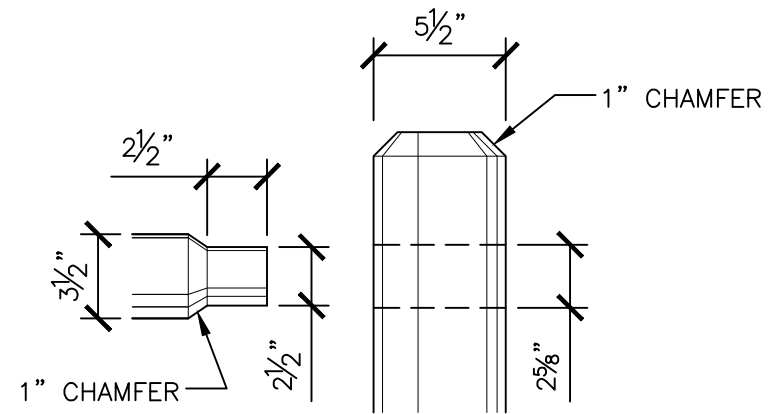

MILLING & DRILLING DIMENSIONS

NOTES:

1. POSTS: 7'x5 1/2" DIA. ROUND POSTS MILLED FROM PINE, OR AS APPROVED BY BELLEVUE PARKS. END AND 90° POST HOLES TO BE DRILLED AT HALF PENETRATION, LINE (180°) POST HOLES TO BE DRILLED AT FULL PENETRATION.
2. RAILS: 10'x3 1/2" DIA. ROUND RAILS MILLED FROM PINE, OR AS APPROVED BY BELLEVUE PARKS.
3. ALL MATERIALS TO BE PT ACQ/CBA, OR APPROVED EQUAL, PRIOR TO SITE DELIVERY AND INSTALLATION.
4. SECURE RAILS BY DRIVING 3" WOOD SCREWS THROUGH THE BACKSIDE (SIDE FACING AWAY FROM TRAIL, PARKING LOT, ETC.) OF POSTS.



City of  
Bellevue

TITLE:

FENCE - POST & (3) RAIL

DRAWING #:	PK-FE-02A
SCALE:	N.T.S.
REVISION DATE:	06-2021
DEPARTMENT:	PARKS